



Fonderie Sime S.p.A. - Via Garbo, 27 - 37045 Legnago (VR) - www.sime.it
Tribunale Verona 13531 - R.E.A. VR 171357 - C.C.P. 19423375 - N° Mecc. VR 014435
Capitale Sociale Euro 5.521.200 int. versato - Codice Fiscale/Partita IVA n. IT 01275930236

Comfort Ambiente - Via Garbo, 27 - 37045 Legnago (VR)

Tel +39 0442 631111 - Fax Servizio Commerciale: Italia +39 0442 631291 - Estero +39 0442 631293

Fax Servizio Tecnico +39 0442 631292 - Fax Ufficio Acquisti +39 0442 631292 - Fax Amministrazione +39 0442 631336

8116626 MIA HE 20 T C10

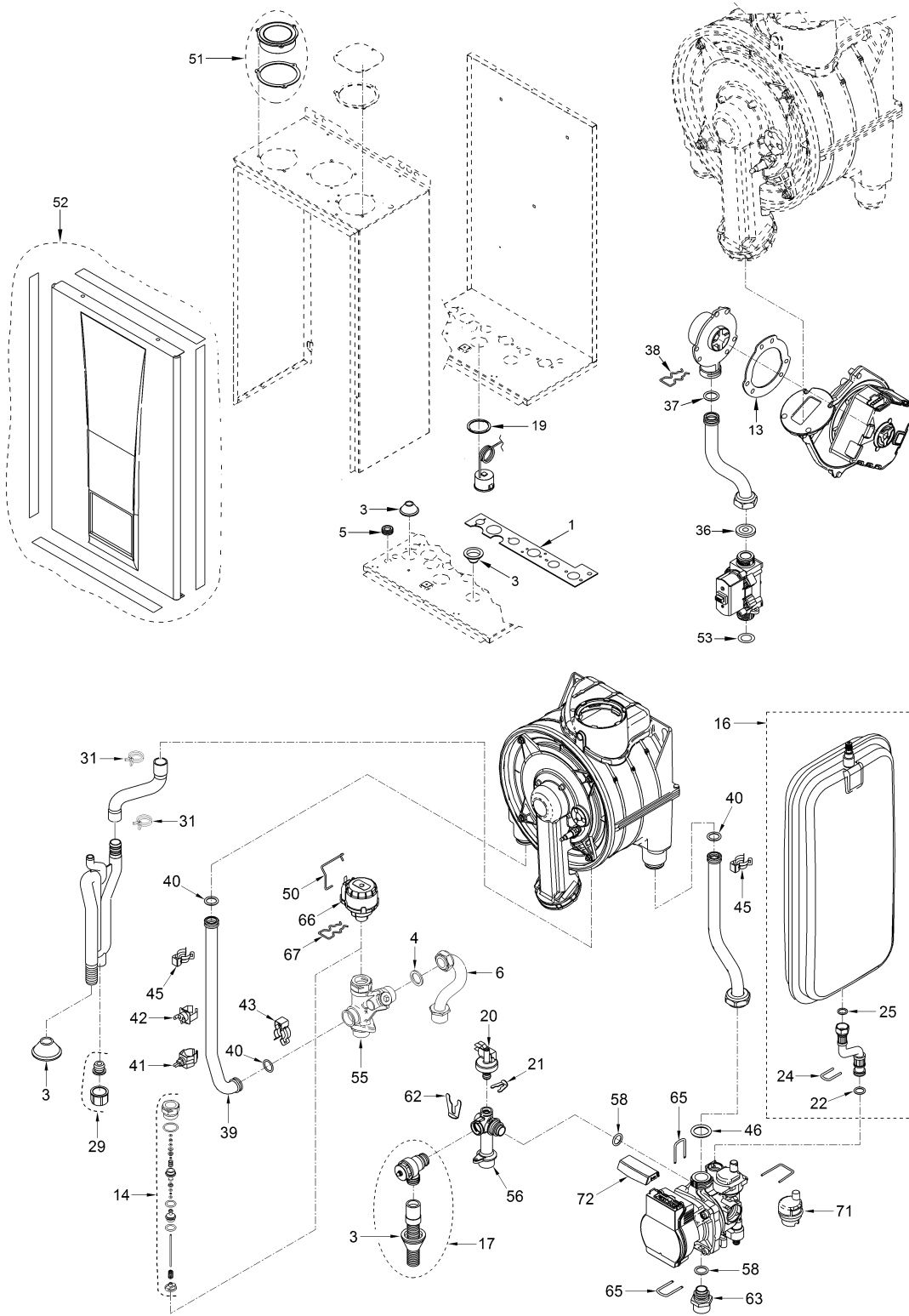

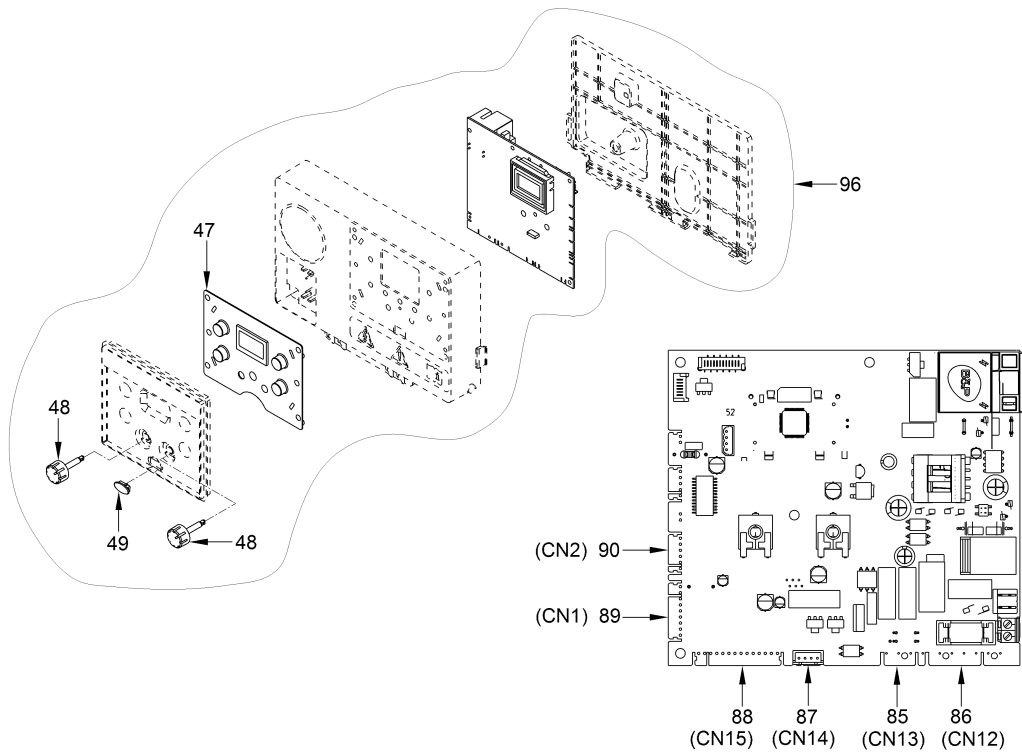
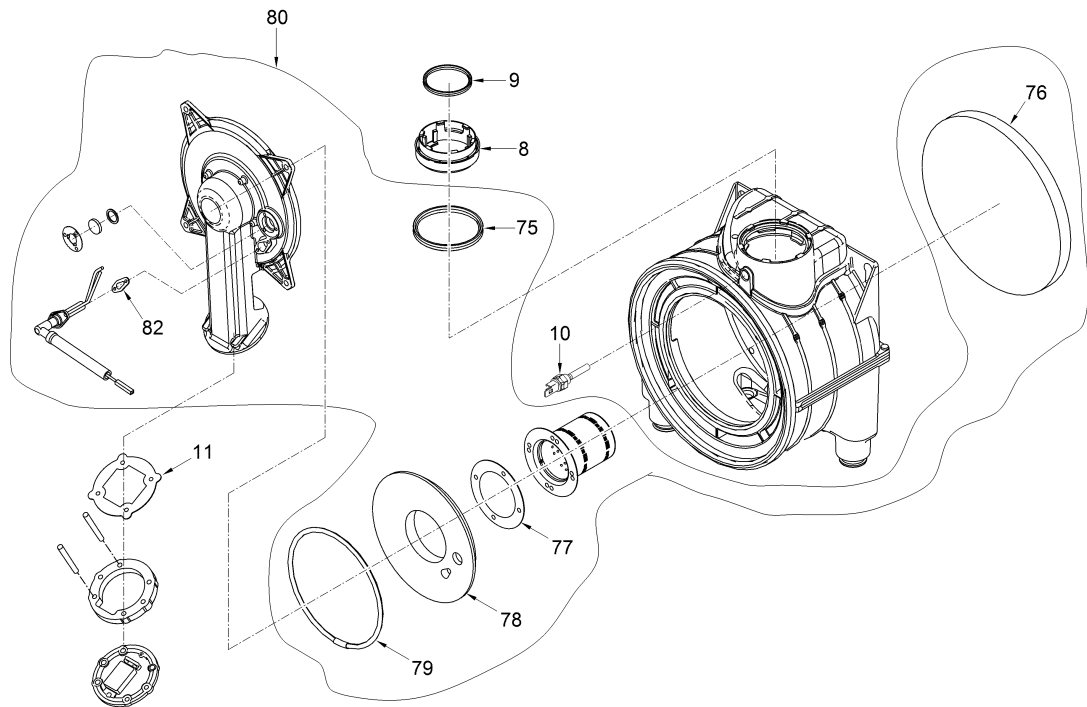

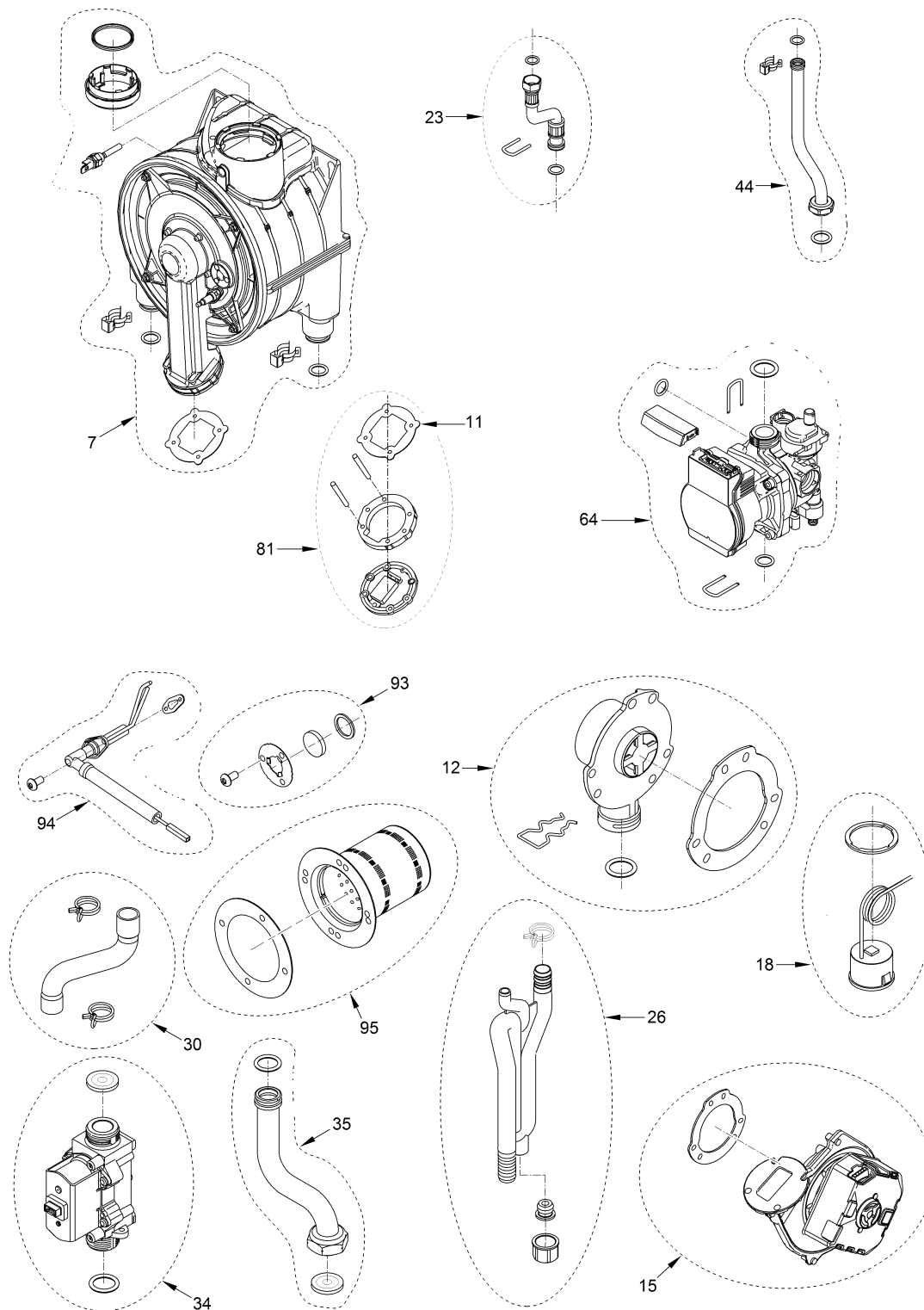

ATTENTION: use only original spare parts. Failure to comply with the above may compromise the safety of the device and the immediate forfeiture of the warranty.

Position	Code	Description	Where used	Advised parts	Price list
001	6229886	Hydraulic group gasket			6.1
002	6226750	Silicone pipe ring øi28			3.09
003	6226753	Silicone pipe ring ø15X35			3.07
004	2030228	Gasket Ø 17x24x2			1.03
005	6226719	Bushing			0.0
006	6265022	D.H.W. storage tank flow pipe			25.1
007	6281758	Heat exchanger+or+spring			390.0
008	6296548	Reducer DN 80-60			4.01
009	6248875	Gasket Ø 60			9.3
010	6277130	Probe NTC D.4X40		A	16.5
011	6174840	Gasket for fan flange			4.05
012	6281750	Group air/gas mixer			25.0
013	6028716	Gasket for fan/mixer			3.2
014	6319645	Three-way plates group		A	19.8

015	6281841	Fan + gasket	A	141.6
016	6281673	Expans. vess.+flex+spring		78.7
017	6281658	Safety valve kit 3 bar + plasti	A	21.5
018	6281670	Hydrometer + gasket		25.9
019	6229881	Gasket		2.04
020	6037512	Water pressure switch		9.9
021	6226639	Spring clip		1.51
022	6226476	ORing diam.15x2		1.27
023	6281632	Flex.pipe MF3/8" L=200 + or		0.0
024	6226643	Pipe fixing spring		2.62
025	2030226	Gasket Ø 10,2x14,8x2		0.86
026	6281764	Water trap group		34.3
029	5171635	Cap + gasket for water trap kit		13.5
030	6281662	Flexible pipe L=210 + spring		19.9
031	2051150	Clamp diam. 25		4.87
034	6281751	Gas valve+gaskets+instr.sheet	A	80.8
035	6281752	Pipe connecting gas valve-mixer		27.6
036	6050469	Nozzle 530 met		4.69
037	6226477	Rubber gasket OR Ø 17x3		1.07
038	6226636	D.H.W. elektrovalve fix.spring		2.31
039	6227557	Flow pipe		13.5
040	6226412	O-ring 3068		1.52
041	6231372	Temperature sensor	A	8.9
042	6146729	100°C safety stat	A	7.4
043	6226601	Spring for heat exchanger conne		2.63
044	6281676	Return pipe C.H.system + or		28.0
045	6226619	Spring for heat exchanger conne		3.83
046	2030267	Piracriten gasket Ø 30x17x2		2.24
047	6305130	Rubber button		9.2
048	6290170	Knob Ø 20		2.48
049	6305140	Rubber cap		1.83
050	6226638	Divertor valve motor spring cli		2.02
051	6281674	Group air intake		18.1
052	6281667	Front panel + insulators		54.1
053	2030249	Gasket Ø 24x17x3		1.58
055	6265890	Flowing to C.H. system manifold		69.7
056	6265880	C.H. return manifold		40.4
058	6226475	ORing diam.18,64x3,53		0.77
062	6226645	Spring clip		2.62
063	6120560	Pump nipple 3/4"		9.5
064	6281681	Circulat. pump + gasket		194.0
065	6226644	Spring clip for rotating connec		1.89
066	6087332	Motor for diverting valve	A	28.0
067	6226636	D.H.W. elektrovalve fix.spring		2.31
071	6013182	Automatic air vent	A	18.9
072	6319647	Circulateur top cover		0.0
075	6248876	Smoke outlet gasket ø80 mm		9.8
076	6326951	Rear insulation + springs		24.3
077	6326942	Gasket for burner flange		5.1
078	6326952	Front insulation		29.2
079	6326953	Sealing		22.2
080	6326981	Burner-door group (clapet)		0.0
081	6281759	Clapet sleeve group		0.0
082	6326950	Gasket for ignition electrode		3.05
083	6105168	Clapet gasket		0.0
085	6329482	Pump-fan CN13 connection		14.5
086	6323875	6 pole cable connector CN12		15.9
087	6323876	4 pole cable connector CN14		4.7
088	6325812	Conn.CN15 s.boll.-press. acqua		17.7
089	6325671	9 pole cable connector CN1		11.4
090	6329474	6 pole cable connector CN2		8.2
093	6281753	Peephole kit		0.0
094	6281754	Ignit.-ionis.elect.+ `asket kit	A	47.7
095	8076123	Burner + gasket kit		61.2
096	6281683	Main P.C.B + keys + knobs	A	163.0
700	5202317	Complete control panel		0.0
701	6316259	5 pole cable connector		9.2
702	6231331	D.H.W. tank sensor B1	A	11.9

A = Spare parts for minimum fittings